

PERMITTING

Tips for meeting Georgia code

<https://www.energycodes.gov/compliance/energy-code-field-studies>

The U.S. Department of Energy (DOE) Building Energy Codes Program is conducting an energy code field study in many states investigating energy code implementation in single family houses. The goal of the study is to help document baseline practices, target areas for improvement, and quantify savings potential. This information is intended to assist states with measuring energy code compliance and to identify areas of focus for future education and training initiatives.

DOE defined these key energy code requirements as having the greatest impact:

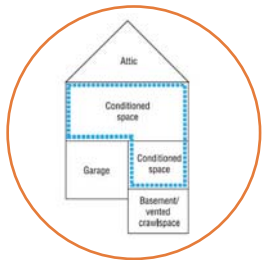

Envelope air tightness (ACH50)



Window SHGC & U-factor

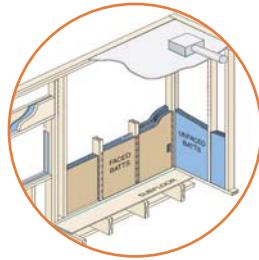

Wall insulation (R-value)

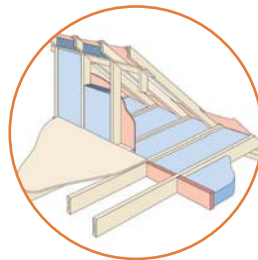

Ceiling insulation (R-value)

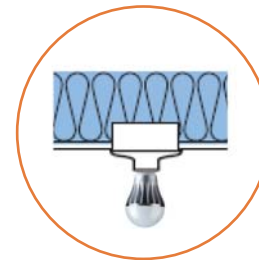

Lighting (% HE lamps)

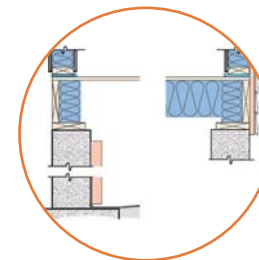

Foundation insulation (R-value)

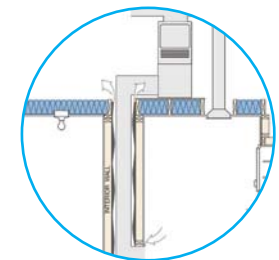

Duct leakage

The top three opportunities:

- Duct Leakage
- Lighting (% HE Lamps)
- Insulation Installation (Walls & Ceilings)

Education & Training



Follow-up evaluation of the same key code requirements to assess if the education and trainings were helpful.

2015



Baseline Data Collection

2016/2017

Completion of education and outreach on common code issues.

2018



Follow-up Data Collection

The baseline study found that the following three key areas needed the most improvement and can achieve the most potential savings from quality installation.

Duct Sealing

Section R403.2.4 of the Georgia code focuses on the need for joints of duct systems to be substantially airtight using tapes, mastics, liquid sealants, gasketing or other approved closure systems.

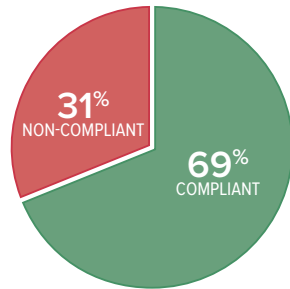

Insulation Installation

To meet the code-required R-values in Table 402.1.1 of the Georgia code, insulation must be installed per manufacturer instructions. All manufacturers require that insulation be free of gaps, voids, misalignment, compression and wind intrusion.

Ceiling Insulation

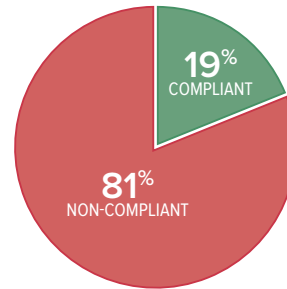

Wall Insulation

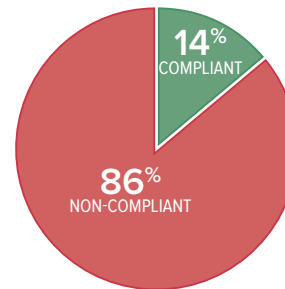

Lighting

Section 404.1 of the Georgia code requires that at least 50 percent of the permanently installed lighting fixtures shall contain only energy efficient bulbs such as CFLs or LEDs.

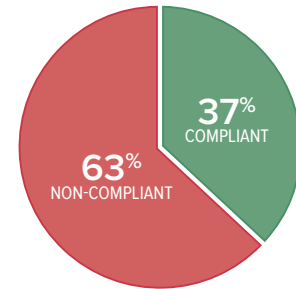

Minimize surprises with the requirements of the Georgia code.

Ensure that code requirements are included at the design and construction phases of each project via:

Construction Documents • Contractor Bid Documents • Conversations with Construction Professionals

Contact Southface with any questions or comments via: energycodes@southface.org or (404) 872-3549

DUCT SEALING

Tips for meeting the duct tightness number

Section R403.2.4 of the Georgia code focuses on the need for joints of duct systems to be substantially airtight by using tapes, mastics, liquid sealants, gasketing or other approved closure systems. The section specifically says, “without exception all closure systems shall have mastic applied that is at least 0.08 inches (2 mm) thick.”

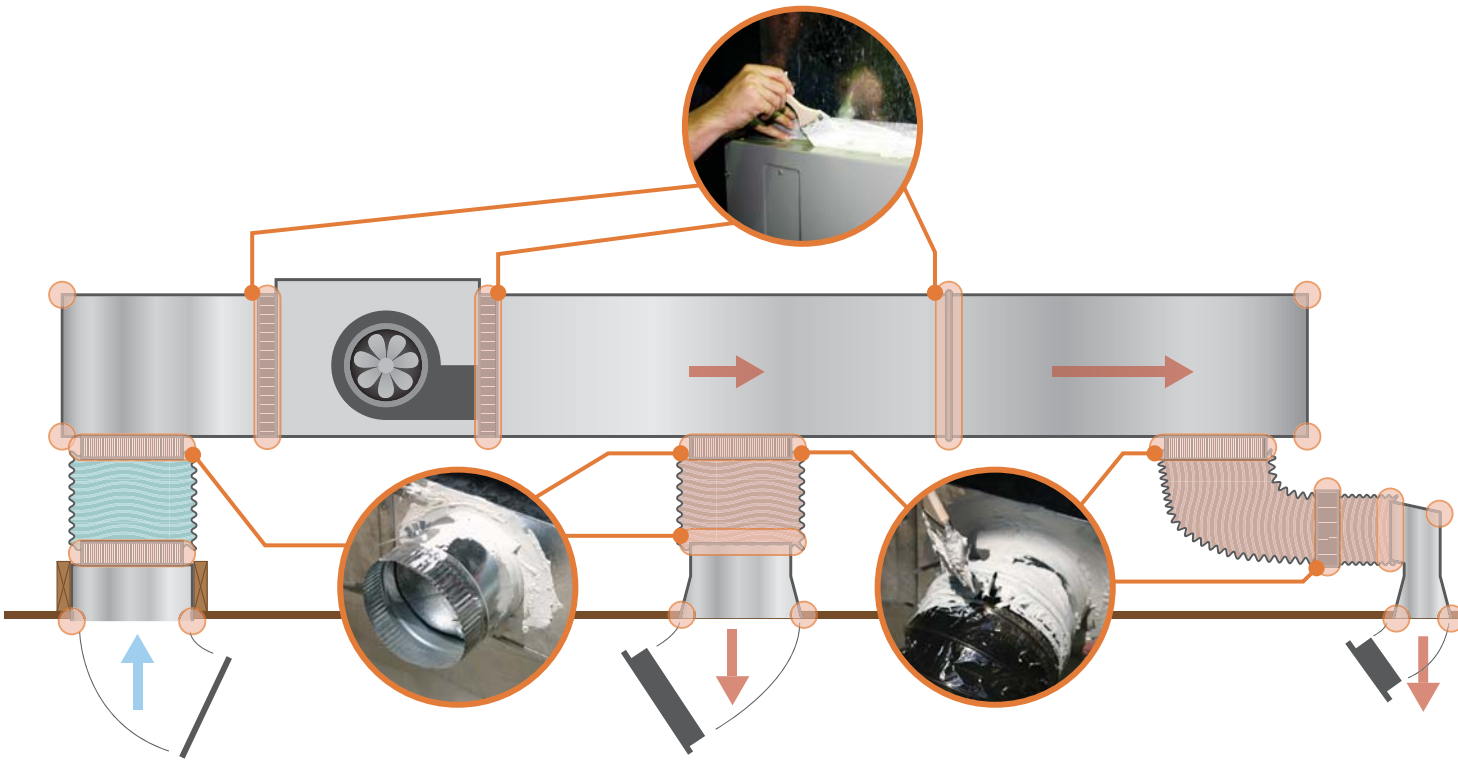

The most common duct leakage sites in an HVAC system include:

- Air Handler to Plenum
- Boot to Gypsum
- Take-Off Collar to Plenum
- Splices
- S and Drive Connections
- Return Platforms
- Inner Liner to Boot Connections
- Inner Liner to Take-Off

Baseline Field Study Results

Duct Leakage

GA Code:

12 CFM25 per 100 square feet total leakage

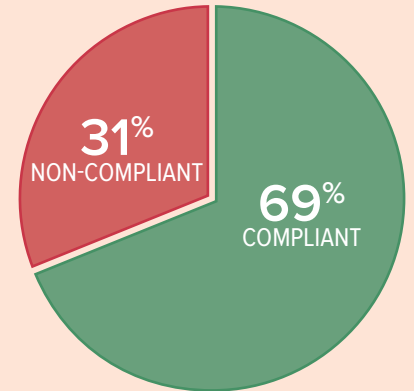

REQUIRED



ALL ducts need to be sealed with mastic - whether they will be tested or not.

Common duct leakage sites

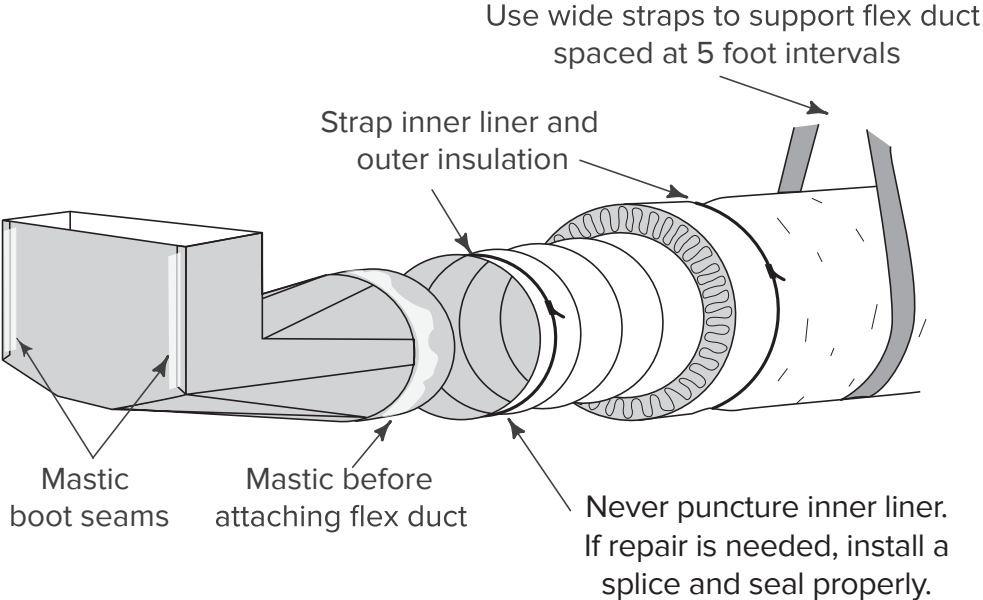

Air Handler to Plenum

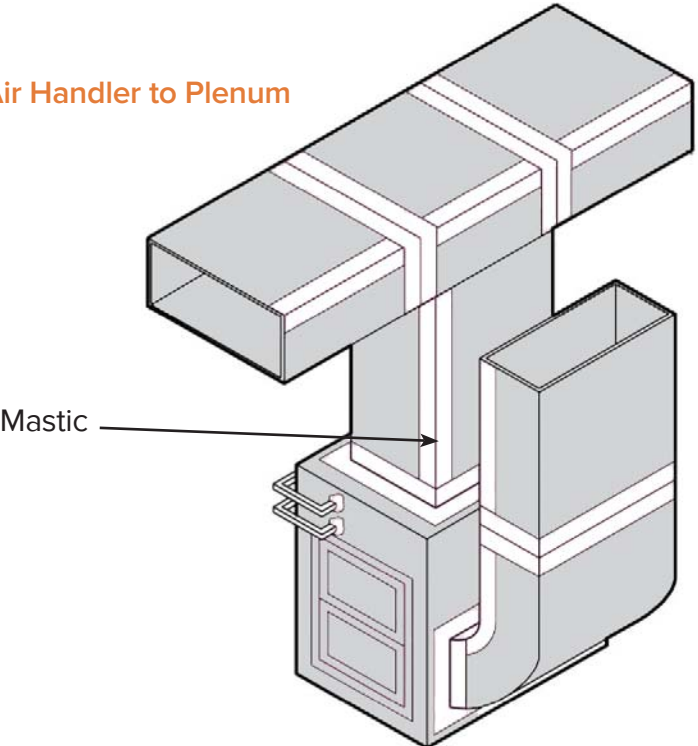

Boot to Gypsum

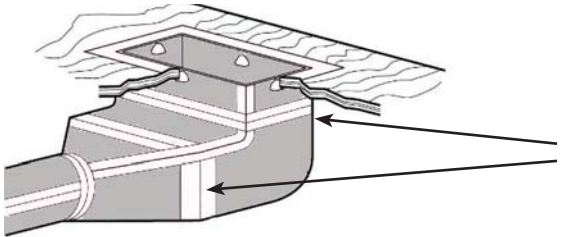

Return Box

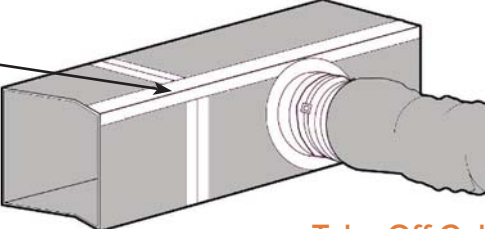
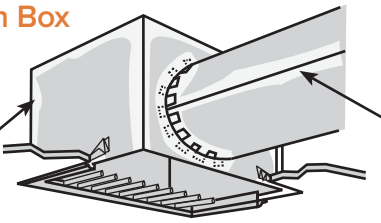

Mastic

Splice

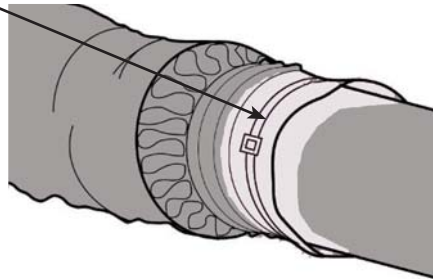

Contact Southface with any questions or comments via: energycodes@southface.org or (404) 872-3549

Where noted, graphics are the property of buildingscience.com. Information published by BSC on buildingscience.com is protected by copyright under U.S. and International copyright laws and conventions. Without the express written permission of BSC or the other copyright holders, the User may not use, distribute, store, modify, publish, transmit or participate in the transfer, sale or reproduction nor create derivative works from, distribute, perform, display or store any part of its material for purposes other than the user's personal, non-commercial use.

INSULATION INSTALLATION

Tips for meeting Georgia code

To meet the code-required R-values in Table 402.1.1, insulation must be installed per manufacturers, installation instructions. All manufacturers require that insulation be free of gaps, voids, misalignment, compression and wind intrusion.

Air Sealing Location

All joints, holes or gaps must be sealed with caulk, foam, gasketing material or other suitable fill.

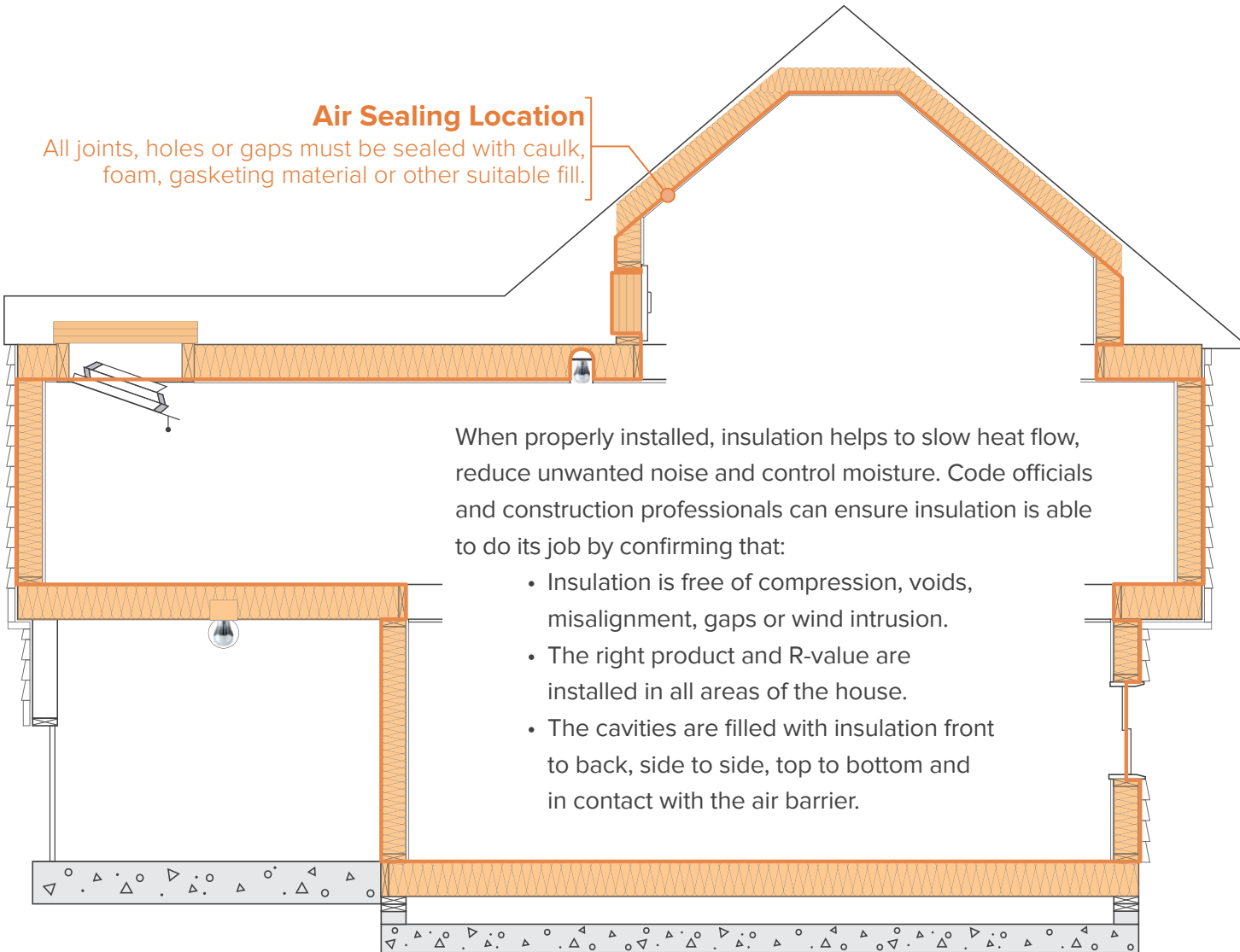

When properly installed, insulation helps to slow heat flow, reduce unwanted noise and control moisture. Code officials and construction professionals can ensure insulation is able to do its job by confirming that:

- Insulation is free of compression, voids, misalignment, gaps or wind intrusion.
- The right product and R-value are installed in all areas of the house.
- The cavities are filled with insulation front to back, side to side, top to bottom and in contact with the air barrier.

Baseline Field Study Results

Ceiling Insulation R-Value

GA Code: Climate Zones 2&3: R-30

Climate Zone 4: R-38

81% COMPLIANT

Ceiling Insulation Quality

19% COMPLIANT



Grade 1



Grade 2



Grade 3

Wall Insulation R-Value

GA Code: R-13

100% COMPLIANT

Wall Insulation Quality

14% COMPLIANT



Grade 1



Grade 2



Grade 3

Example details from Appendix A of the GA code

Complete resources available at: www.southface.org/resources

Standard Truss
with tapered
insulation depth

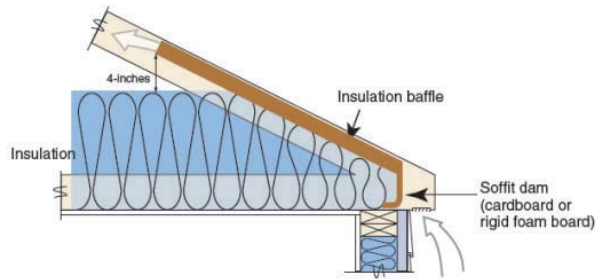

Energy Truss
with full height insulation
(recommended)

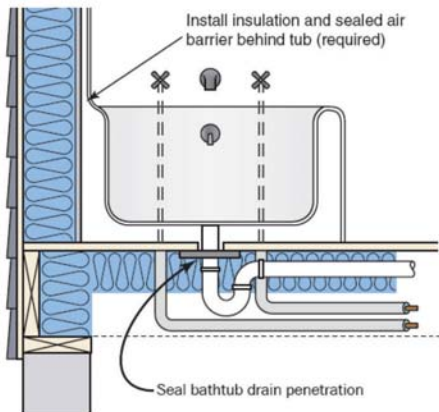
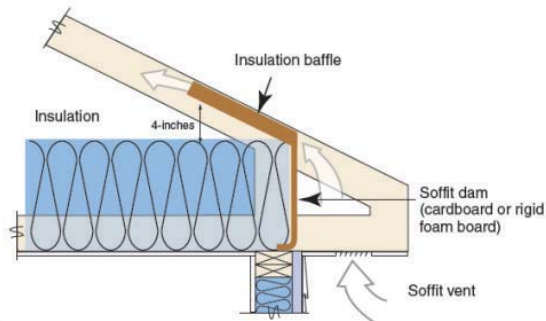

Inspecting Insulation

- Air sealing
- Baffling
- Obstructions
- Odd-sized cavities

Inspecting Insulation

- Tubs
- Showers
- Fireplaces
- Attic knee walls

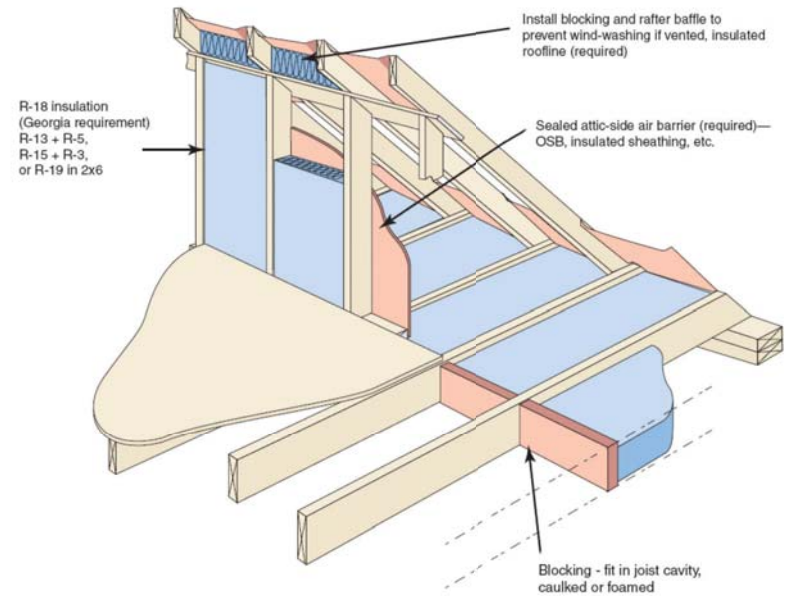
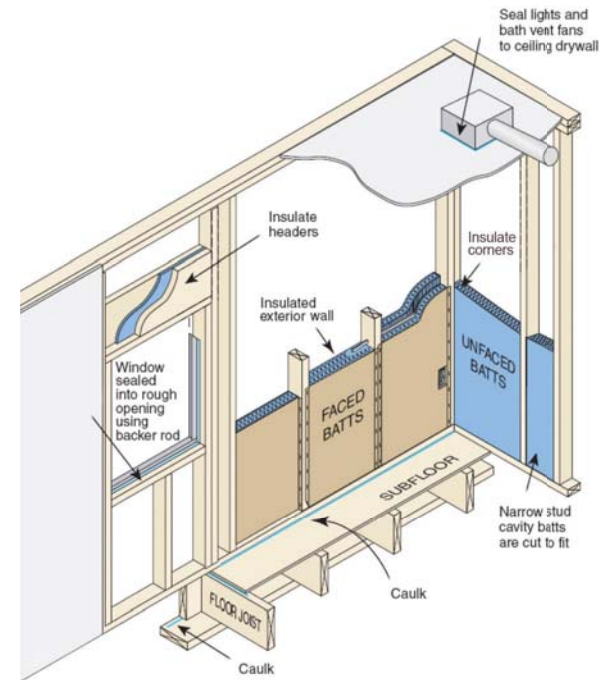

Contact Southface with any questions or comments via: energycodes@southface.org or (404) 872-3549

LIGHTING

Tips for meeting Georgia code

The lighting industry has been transformed by compact fluorescent lamp (CFL) and light-emitting diode (LED) technologies because of their high performance and energy efficiency. Not only should CFLs and LEDs be considered for building lighting solutions, but section 404.1 of the code requires that at least 50 percent of the permanently installed lighting fixtures:

- contain high-efficacy lamps (e.g., energy efficient bulbs), or
- be controlled by an occupancy/vacancy sensor (e.g., motion sensor) or
- be controlled by automated lighting controls (e.g., timers)

The visual below shows the common way to meet the code for lighting equipment: using CFLs and/or LEDs for at least half of a home's bulbs.



LED



CFL

$\geq 50\%$
Combination of Both



Incandescent

$\leq 50\%$
Incandescents

Baseline Field Study Results





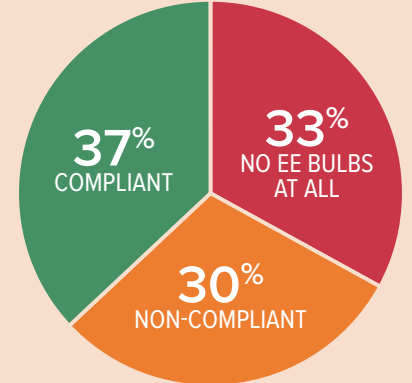

High-Efficacy Lighting

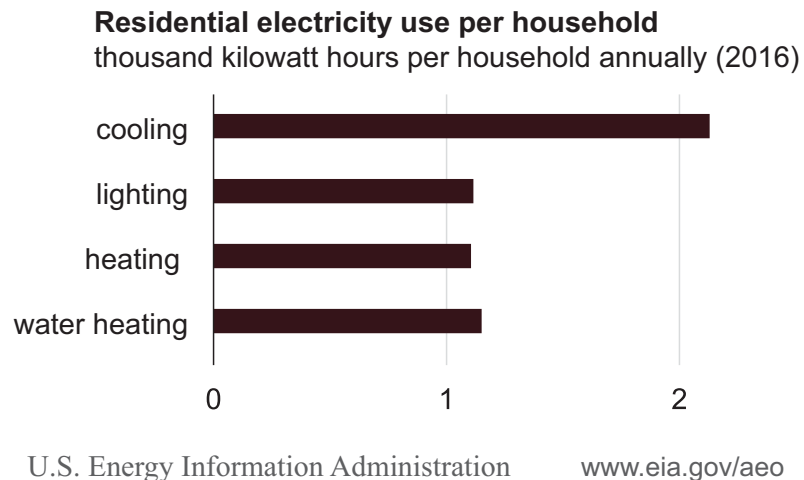
Georgia Code: 50% of the total lights in the home



Enforcing lighting code requirements is important and easy to do:



			
800 Lumens	60W	14W	13W
Avg. 20-year cost	\$326	\$88	\$61
# of bulbs per location	23	3	1
			
	NON-COMPLIANT	COMPLIANT	COMPLIANT

Note: Cost comparison is based on a 20-year life and takes into account power consumption, hours of use per day, residential electricity cost, bulb cost and replacement cost. For detailed cost calculations and a full pro/con list, visit <http://Lighting.MnCERTs.org>.

MAKE LIGHTING INSPECTIONS EASIER:

- Look for the ENERGY STAR label
- Use a **lighting ballast discriminator**, an electronic sensor that indicates if lighting is energy efficient.



A lighting ballast discriminator can detect the frequency of a bulb's ballast with the simple push of a button, telling you what type of bulb is present. A green light indicates a CFL or an LED, while a red light indicates an incandescent.



Contact Southface with any questions or comments via: energycodes@southface.org or (404) 872-3549